

The boa family is an M-COTS, low profile, fully compliant base plate cooled DCDC power supply with a fully regulated output of up to 600W.

Designed for harsh military applications, the units are available with a wide 9 to 38VDC input for 12V and 28V military systems, for both platform and terminal connected equipment.

Integral EMC filtering to MIL-STD 461 and surge protection to MIL-STD 704/ 1275/ DEF-STAN 61-5 part 6 issue 5/6 allows for direct connection to the supply voltage. Optional load dump feature provides full ride through protection against the 202V DC surge required to meet the DEF-STAN 61-5 part 6 issue 6 with no loss of output voltage.

Compliance to UK vehicle EMC specification DEF-STAN 59-411 Land Class A is met with an additional input EMI filter, and on-systems can provide technical support with the implementation of this filter.

- Wide DC input range; 9V to 38VDC
- MIL-STD 1275A-E | MIL-STD 704A-F | DO-160E-G
- DEF-STAN 61-5 part 6 issue 5/6
- MIL-STD 461 E-F EMC Compliance
- DEF-STAN 00-35 & MIL-STD 810 D-F Environmental Compliance
- Fully regulated output power over the full input range
- Efficiency up to 92%
- 3 Year warranty
- >300,000 hours MTBF
(MIL-STD 217F, GB, 25°C)
- CE Marked LVD & EMC



for further information please contact on-systems

0844 809 4608

sales@on-systems.co.uk

www.on-systems.co.uk

Part Number Characteristics; 50W to 150W

Part Number	Output Power	Input Voltage Range	Output Voltage	Output Load regulation	Max Output Current	Output Ripple & Noise pk-pk	Current Limit Set Point	Efficiency (Typical at full load)
BOA75M-W20-S3v3	75W	9-38V DC	3.3V DC	0.2%	12A	100mV	110%-140%	81%
BOA75M-W20-S5	75W	9-38V DC	5V DC	0.2%	12A	100mV	110%-140%	84%
BOA75M-W20-S12	75W	9-38V DC	12V DC	0.2%	6.25A	150mV	110%-140%	86%
BOA75M-W20-S15	75W	9-38V DC	15V DC	0.2%	5A	150mV	110%-140%	86%
BOA75M-W20-S24	75W	9-38V DC	24V DC	0.2%	3.12A	240mV	110%-140%	86%
BOA100M-W20-S3v3	100W	9-38V DC	3.3V DC	0.2%	30A	100mV	110%-140%	81%
BOA100M-W20-S5	100W	9-38V DC	5V DC	0.2%	20A	100mV	110%-140%	86%
BOA100M-W20-S12	100W	9-38V DC	12V DC	0.2%	8.3A	150mV	110%-140%	86.5%
BOA100M-W20-S15	100W	9-38V DC	15V DC	0.2%	6.7A	150mV	110%-140%	86.5%
BOA100M-W20-S24	100W	9-38V DC	24V DC	0.2%	4.17A	240mV	110%-140%	86.5%
BOA150M-W20-S5	150W	9-38V DC	5V DC	0.2%	30A	100mV	110%-160%	92%
BOA150M-W20-S12	150W	9-38V DC	12V DC	0.2%	12.5A	150mV	110%-160%	92%
BOA150M-W20-S24	150W	9-38V DC	24V DC	0.2%	6.3A	280mV	110%-160%	89.5%
BOA150M-W20-S28	150W	9-38V DC	28V DC	0.2%	5.4A	280mV	110%-160%	90%
BOA150M-W20-S48	150W	9-38V DC	48V DC	0.2%	3.2A	480mV	110%-160%	90.5%

for further information please contact on-systems

0844 809 4608
sales@on-systems.co.uk

www.on-systems.co.uk

Part Number Characteristics; 200W to 300W

Part Number	Output Power	Input Voltage Range	Output Voltage	Output Load regulation	Max Output Current	Output Ripple & Noise pk-pk	Current Limit Set Point	Efficiency (Typical at full load)
BOA200M-W20-S3v3	200W	9-38V DC	3.3V DC	0.2%	50A	100mV	110%-150%	87%
BOA200M-W20-S5	200W	9-38V DC	5V DC	0.2%	40A	100mV	110%-150%	87%
BOA200M-W20-S12	200W	9-38V DC	12V DC	0.2%	16.7A	150mV	110%-150%	86%
BOA200M-W20-S15	200W	9-38V DC	15V DC	0.2%	13.3A	150mV	110%-150%	87%
BOA200M-W20-S24	200W	9-38V DC	24V DC	0.2%	8.3A	240mV	110%-150%	87%
BOA200M-W20-S28	200W	9-38V DC	28V DC	0.2%	7.14A	280mV	110%-150%	88.5%
BOA200M-W20-S48	200W	9-38V DC	48V DC	0.2%	4.2A	480mV	110%-150%	86%
BOA300M-W20-S5	300W	9-38V DC	5V DC	0.2%	60A	100mV	110%-160%	88.5%
BOA300M-W20-S12	300W	9-38V DC	12V DC	0.2%	25A	120mV	110%-160%	91%
BOA300M-W20-S15	300W	9-38V DC	15V DC	0.2%	20A	200mV	110%-160%	91%
BOA300M-W20-S24	300W	9-38V DC	24V DC	0.2%	12.5A	280mV	110%-160%	88%
BOA300M-W20-S28	300W	9-38V DC	28V DC	0.2%	10.7A	280mV	110%-160%	88.5%
BOA300M-W20-S48	300W	9-38V DC	48V DC	0.2%	6.25A	480mV	110%-160%	88%

for further information please contact on-systems

0844 809 4608

sales@on-systems.co.uk

www.on-systems.co.uk

Part Number Characteristics; 400W to 600W

Part Number	Output Power	Input Voltage Range	Output Voltage	Output Load regulation	Max Output Current	Output Ripple & Noise pk-pk	Current Limit Set Point	Efficiency (Typical at full load)
BOA400M-W20-S5	400W	9-38V DC	5V DC	0.5%	80A	100mV	110%-150%	87.5%
BOA400M-W20-S12	400W	9-38V DC	12V DC	0.5%	33.3A	120mV	110%-150%	86%
BOA400M-W20-S24	400W	9-38V DC	24V DC	0.5%	16.7A	240mV	110%-150%	87%
BOA400M-W20-S28	400W	9-38V DC	28V DC	0.5%	14.3A	280mV	110%-150%	87%
BOA400M-W20-S48	400W	9-38V DC	48V DC	0.5%	8.3A	480mV	110%-150%	86.5%
BOA600M-S28-S12	600W	18-36V DC	12V DC	0.5%	50A	120mV	110%-150%	88%
BOA600M-S28-S24	600W	18-36V DC	24V DC	0.5%	25A	240mV	110%-150%	89%
BOA600M-S28-S28	600W	18-36V DC	28V DC	0.5%	21.5A	280mV	110%-150%	90%
BOA600M-S28-S32	600W	18-36V DC	32V DC	0.5%	19A	320mV	110%-150%	91%
BOA600M-S28-S48	600W	18-36V DC	48V DC	0.5%	12.5A	480mV	110%-150%	91%
BOA600M-S48-S12	600W	36-75V DC	12V DC	0.5%	50A	120mV	110%-150%	90%
BOA600M-S48-S24	600W	36-75V DC	24V DC	0.5%	25A	240mV	110%-150%	92%
BOA600M-S48-S28	600W	36-75V DC	28V DC	0.5%	21.5A	280mV	110%-150%	91%
BOA600M-S48-S32	600W	36-75V DC	32V DC	0.5%	19A	320mV	110%-150%	93%
BOA600M-S48-S48	600W	36-75V DC	48V DC	0.5%	12.5A	480mV	110%-150%	93%

for further information please contact on-systems

0844 809 4608

sales@on-systems.co.uk

www.on-systems.co.uk

Part Number Configuration

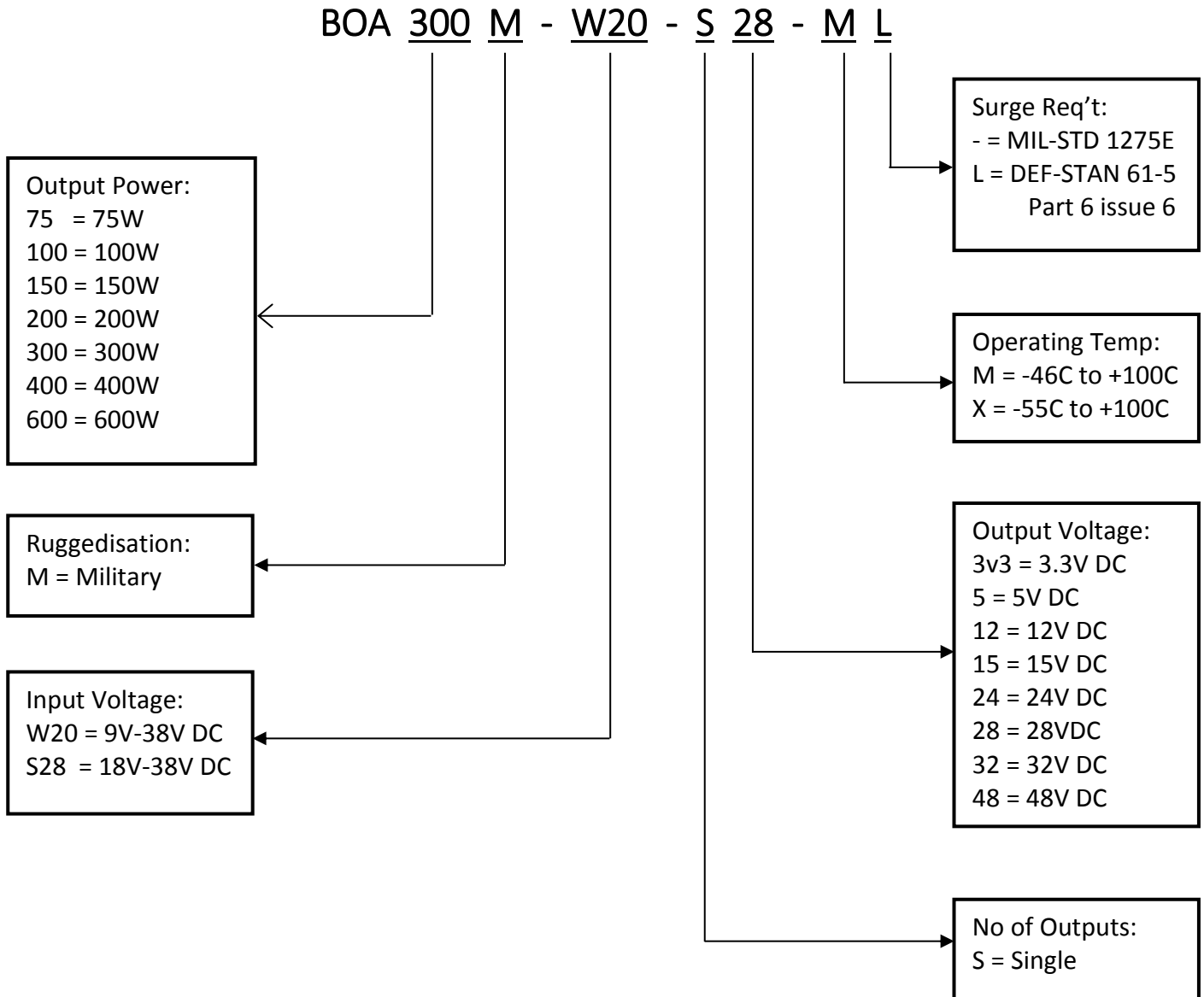

All units are available with 18V-38V DC input range, simply substitute W20 for S28 in the part number configuration.

All output voltages can be factory adjusted to your specific required voltage. Please contact your sales advisor for more information.

for further information please contact on-systems

0844 809 4608

sales@on-systems.co.uk

www.on-systems.co.uk

Environmental Specifications

Shock:	DO-160G Shock $\pm 6g$, 11ms in any direction BS EN60068-2-27 15g shock 11ms $\frac{1}{2}$ sine
Vibration:	DO-160G Section 8 Procedure 8.7.2 Test Level C1
Operating Humidity:	DO-160G Section 6 category B; 90%
Operating Temperature:	-46C to +100C Standard -55C to +100C Option X
Storage Temperature:	-55C to +125C Standard -65C to +125C option X
Operating Altitude:	+51,000ft -1,500ft
Over-temperature Shutdown:	+110C, automatic restart at 95C
Cooling:	Conduction cooled through base plate
RoHS:	Directive 2002-95-EC
WEEE:	Directive 2002-96-EC
REACH:	EU-1907-2006
HAZMAT compliant	
Design Lifetime:	Units are designed for minimum 15 years' service life, and the unit does not contain any components that require periodic maintenance

EMC

Safety Approvals:	EN60950-1:2006
Emissions:	MIL-STD 461F DEF-STAN 59-411 with additional filter
ESD Immunity:	EN61000-4-2, Level 3
Radiated Immunity:	EN61000-4-3, 10V/m, Level 3 Performance criteria A
Surge:	EN61000-4-5, Installation class 3, Performance criteria A
Conducted Immunity:	EN61000-4-6, 10V RMS, Performance criteria A

for further information please contact on-systems

0844 809 4608

sales@on-systems.co.uk

www.on-systems.co.uk

Standard Signals and Indicators

36V clamped output for auxiliary equipment (max 3A)

Global Disable – Turns off the main output and the auxiliary output, reference input 0V

Regulated Output Disable – Turns off the main regulated output, reference output 0V

Remote Sense – to compensate for output voltage drops in cables (compensation up to 0.5V across the leads)

Global PSU OK – Floating open collector: Closed = PSU OK, Open = PSU FAIL

Base plate Temperature Signal – Provides an accurate voltage proportional to the internal PSU temperature.

This signal can be used to warn of potential over temperature situation that may be the result of a system cooling failure, vastly improving the up-time of a system.

for further information please contact on-systems

0844 809 4608

sales@on-systems.co.uk

www.on-systems.co.uk

Connections & Pinouts

CN1 Main Input Connector & CN2 Main Output Connector

Pair of M4 studs for connecting + & - Input/Output

CN3 Input Signals Connector

PCB (B8B-PHDSS) mating half is PHDR-08VS housing, crimps SPHD-001T-P0.5

- 1 Auxiliary output – Unregulated and clamped to 36V DC (max 3A), referenced to input 0V.
- 2 Input side 0V
- 3 Disable - connect to input 0V to turn all outputs off, leave open/high to turn all outputs on.
- 4 n/c
- 5 Parallel positive input (available only on 200W and greater)
- 6 Parallel positive output (available only on 200W and greater)
- 7 Parallel negative input (available only on 200W and greater)
- 8 Parallel negative output (available only on 200W and greater)

CN4 Output Signals Connector

PCB (B10B-PHDSS) mating half is PHDR-10VS housing, crimps SPHD-001T-P0.5

- 1 n/c
- 2 Remote sense negative (trim 0.5V max) – (not fitted on chassis type A)
- 3 n/c
- 4 Remote sense positive (trim 0.5V max) – (not fitted on chassis type A)
- 5 DC OK - (emitter of an opto isolator 20mA max) Short = DC OK
- 6 DC OK + (collector of an opto isolator 20mA max) Short = DC OK
- 7 n/c
- 8 Base plate temperature signal (23 deg C = 580mV),
referenced to the output 0V $VO = (+6.25 \text{ mV/}^\circ\text{C} \times T \text{ }^\circ\text{C}) + 424 \text{ mV}$
Temperature (T) Typical VO
+125°C +1205 mV
+100°C +1049 mV
+25°C +580 mV
0°C +424 mV
-25°C +268 mV
-40°C +174 mV
- 9 Output disable (+) (5v applied across this pin and pin 10 disables the regulated output)
- 10 Output disable – (used in conjunction with pin 9)

for further information please contact on-systems

0844 809 4608

sales@on-systems.co.uk

www.on-systems.co.uk

Application Notes for Signals

Output Disable

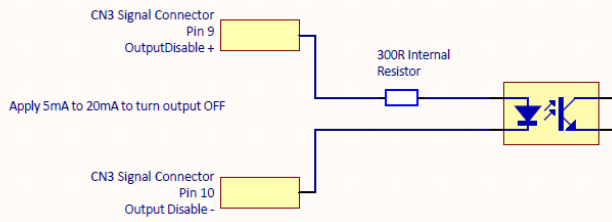

Apply 5mA to 20mA to turn output OFF

Apply a potential to the input pins in excess of 5mA to turn unit off

Example 1
5V supply

Target I = 10mA
R = 300R
 $I = (V_{supply} - 2V) / 300$
 $I = 0.01A$ or 10mA

In this example the internal 300 ohms resistor is adequate and 5V can be applied straight to the disable pins

Example 2
28V supply

Target I = 10mA
 $R = (V_{supply} - 2V) / 10mA$
 $R = (28 - 2) / 10mA$
R = 2,600 ohms
R = 2K6R - 300R = 2,300R

An external current limit resistor of 2K3 in series with a 28V rail

Temperature output

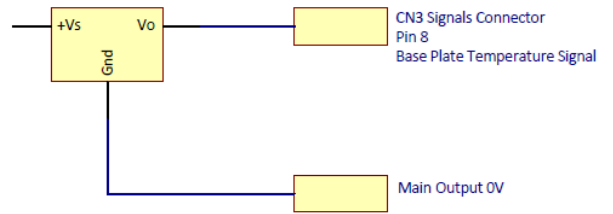

This signal is referenced to the Zero Volt output.

A current of < 1mA can be driven from this device

The Formula to calculate temperature is

$$T = (V_O - 424mV) / 6.25mV$$

Example 1
Where $V_O = 580mV$

$$T = (580 - 424) / 6.25$$

$$T = 25C$$

Example 2
Where $V_O = 1049mV$

$$T = (1049 - 424) / 6.25$$

$$T = 100C$$

DC OK

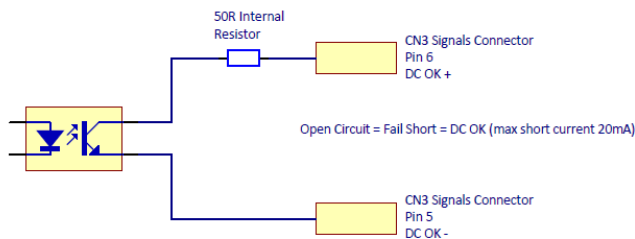

Both these pins are isolated so can be tied to any rail to achieve a signal

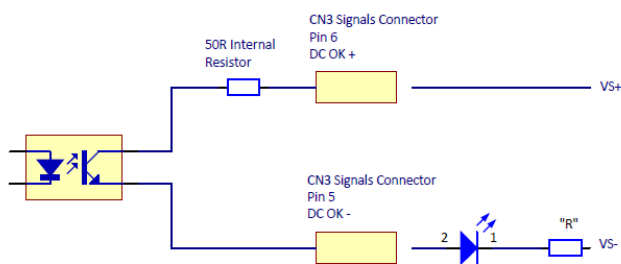

The above circuit shows how an LED can be driven from the DC OK signal

Example

V_{S+} is 12V, V_{S-} is 0V
LED current is 20mA, LED voltage is 2V

$$"R" = (12 - 2) / 20mA$$

$$"R" = 10 / 0.02$$

$$R = 500 \text{ ohms}$$

Placing a 500 ohm resistor in series with a 20mA LED will provide a DC OK

LED ON = DC OK OFF = DC Fail

for further information please contact on-systems

0844 809 4608

sales@on-systems.co.uk

www.on-systems.co.uk

Mechanical Drawing & Pinouts

75W to 150W Chassis

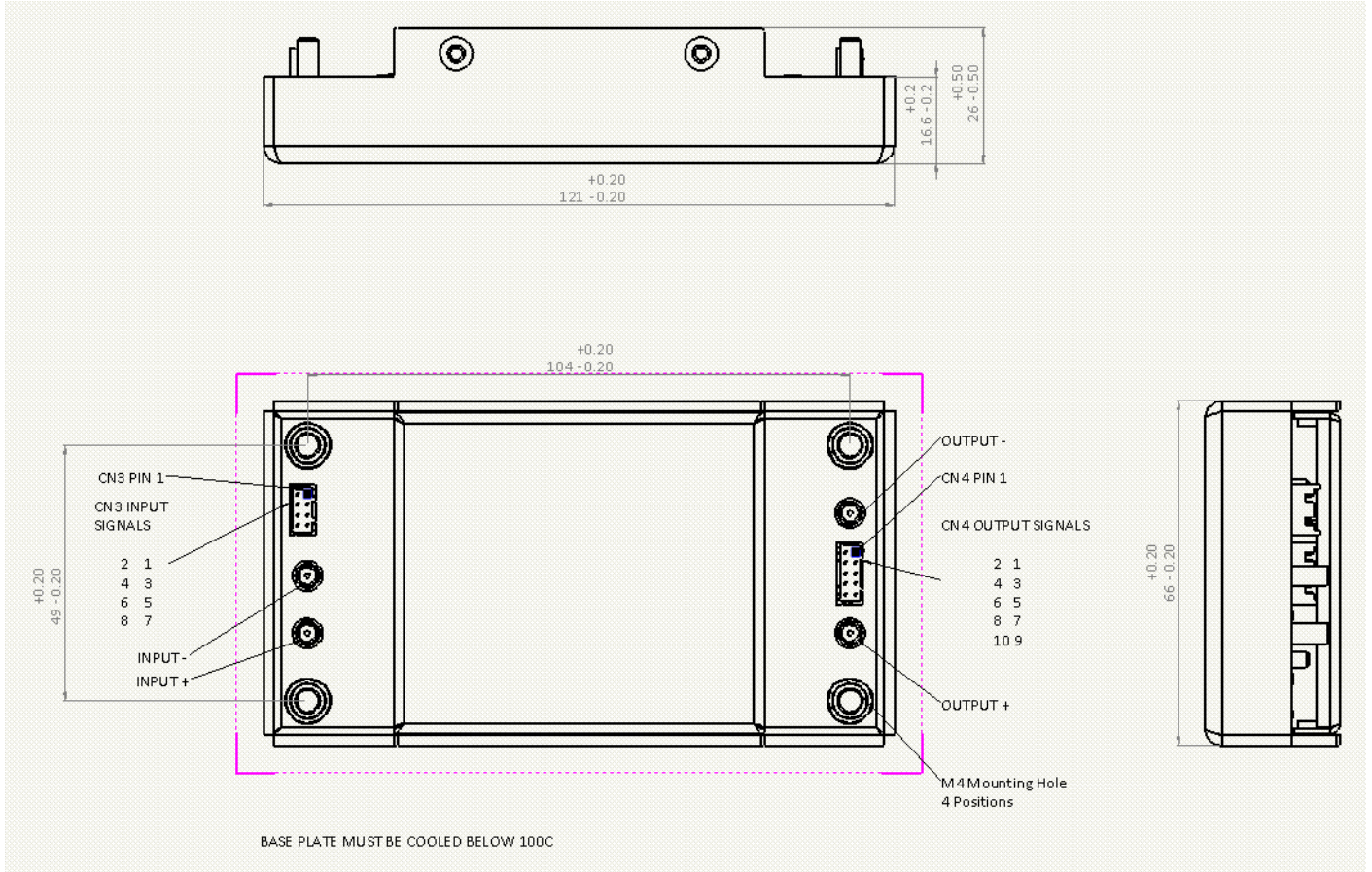

for further information please contact on-systems

0844 809 4608

sales@on-systems.co.uk

www.on-systems.co.uk

Mechanical Drawing & Pinouts

200W to 300W

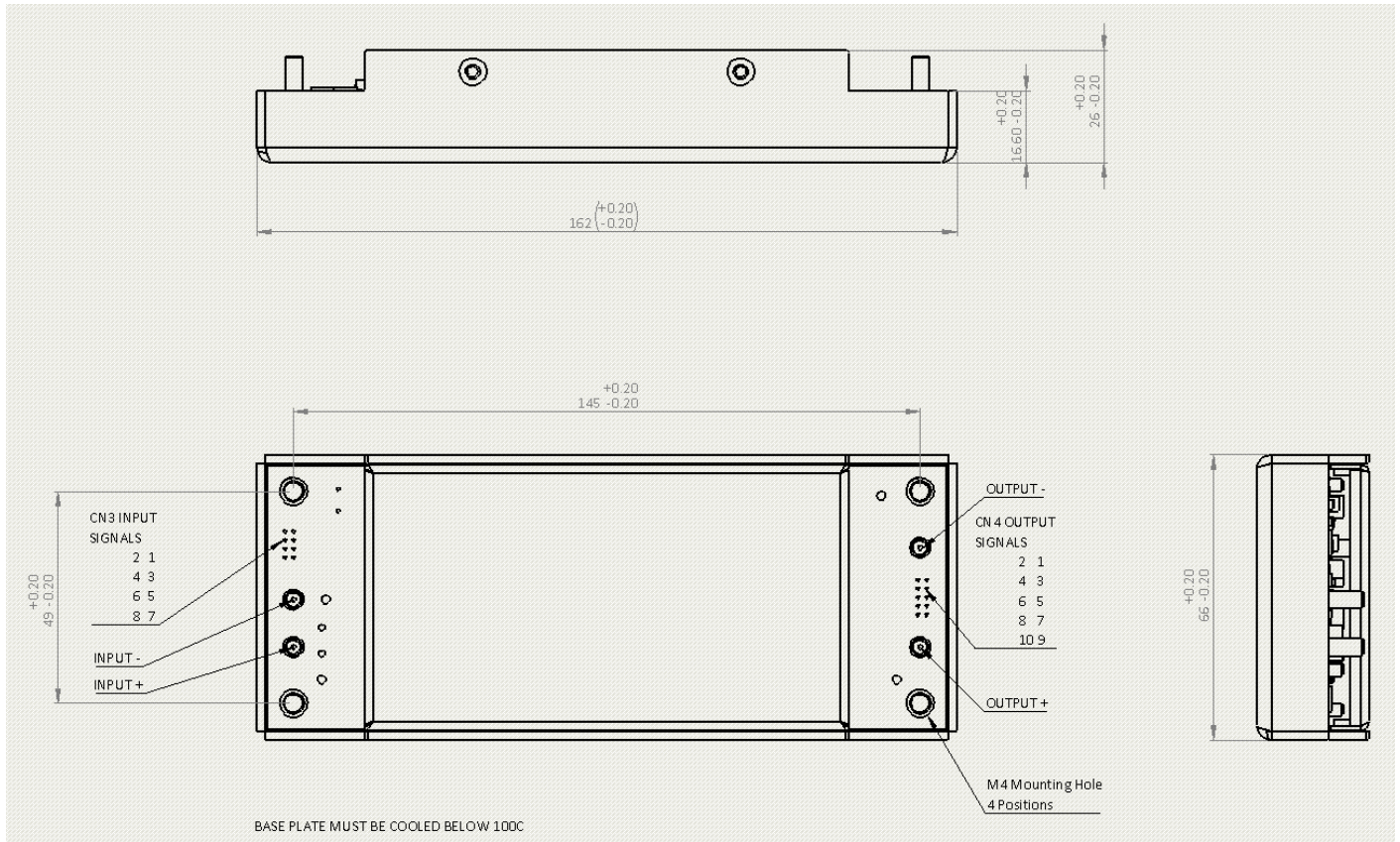

for further information please contact on-systems

0844 809 4608

sales@on-systems.co.uk

www.on-systems.co.uk

Mechanical Drawing & Pinouts

400W to 600W

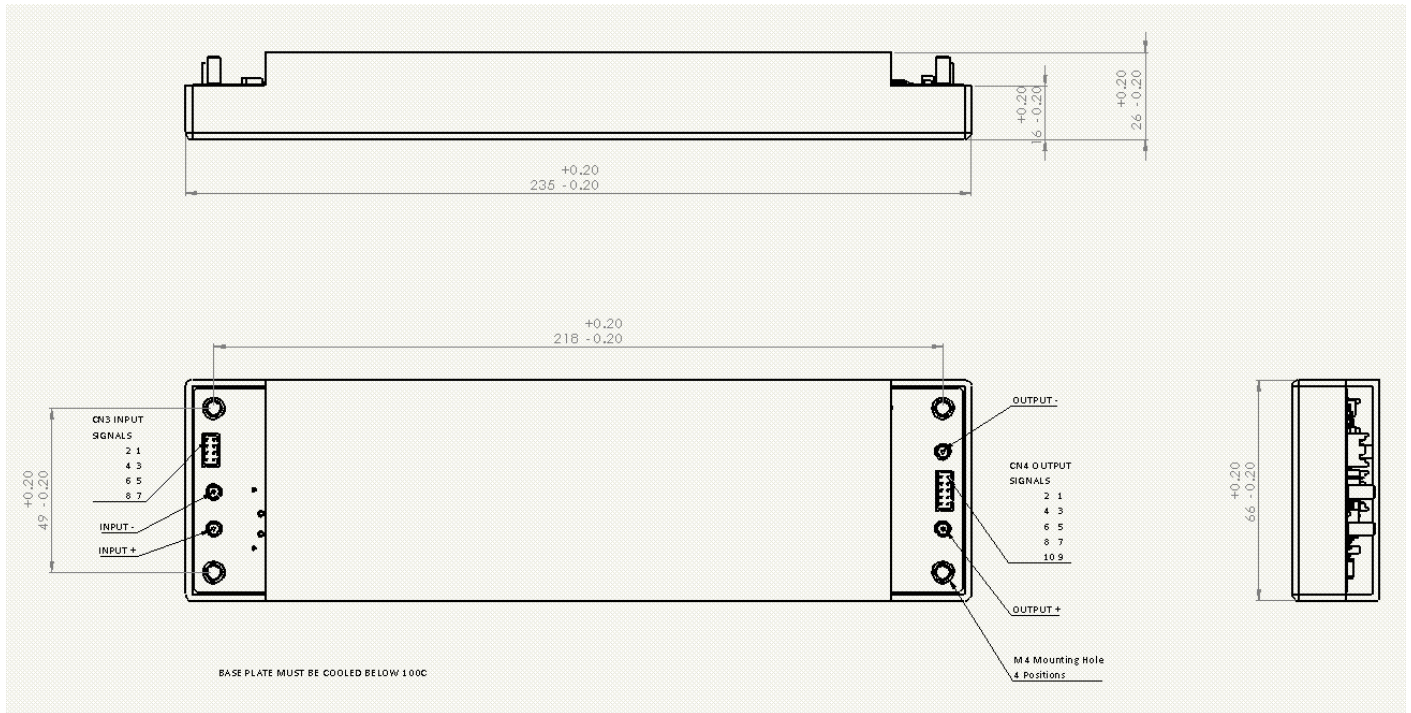

for further information please contact on-systems

0844 809 4608

sales@on-systems.co.uk

www.on-systems.co.uk